



WATER FILTRATION SYSTEM INSTALLATION, MAINTENANCE AND MANAGEMENT MANUAL

Jal-TARA Slow Sand Filter User Guide



Government of India
Department of Science & Technology
Ministry of Science & Technology



WATER FILTRATION SYSTEM INSTALLATION, MAINTENANCE AND MANAGEMENT MANUAL Jal-TARA Slow Sand Filter User Guide

ISBN	:	978-81-87395-78-2 (8)
Published by	:	Development Alternatives B-32, Tara Crescent, Qutub Institutional Area New Delhi 110016, India Tel: +91-11-2654-4100, 2654-4200 Fax: +91-11-2685-1158 Email: mail@deval.org, Website: www.deval.org
Cover Photo Credit	:	Development Alternatives
Author(s)	:	Zeenat Niazi, Pankaj Khanna, Suhani Gupta, Rashi Sirohi
Layout	:	Binu K George

Disclaimer

This document is an outcome of a project titled, "Delivery of Eco-Friendly Multi-Hazard Resistant Construction Technologies and Habitat Solutions in Mountain States, Focus: Uttarakhand" funded by "The Department of Science and Technology (DST), New Delhi" for the economic development, social empowerment and environment management of our society. This document is intended for use by policy-makers, academia, government, non-government organisations and general public for guidance on matters of interest only. The decision and responsibility to use the information contained in this document lies solely with the reader. The author(s) and the publisher(s) are not liable for any consequences as a result of use or application of this document. Content may be used/quoted with due acknowledgement to Development Alternatives.



This work is licensed under the Creative Commons Attribution-NonCommercial-ShareAlike 4.0 International License.

Suggested Citation

Niazi, Z., Khanna, P., Gupta, S., and Sirohi, R. (2020) *Water Filtration System Installation, Maintenance and Management Manual - Jal-TARA Slow Sand Filter User Guide*. New Delhi: Development Alternatives.

TABLE OF CONTENTS

1. Background	5
2. Jal-TARA water filter technology	8
2.1 Concept	9
2.2 Advantages	9
2.3 Filtration mechanism	9
2.4 Design of filtration system	10
2.5 Components of filtration system	11
2.6 Platform for water tanks	11
2.7 Jal-TARA water filter	11
2.8 Plumbing	12
3. Installation and Operation	15
3.1 Site selection	16
3.2 Identification of the filter media	17
3.3 Construction of platform for water filter tanks	19
3.4 Preparation and installation of Jal-TARA filter	19
3.5 Plumbing connections	21
3.6 Operationalizing the filter	21
4. Maintenance	24
5. Ownership and Management	28
6. Cost of the system	31

INTRODUCTION

This manual has been prepared as part of a project on '*Delivery Model for Eco-friendly Multi Hazard Resistant Construction Technologies and Habitat Solutions in Mountain States*', which has been implemented in Uttarkashi (Uttarakhand) under the TIME LEARN (Technology Innovation in Mountain Ecosystem Livelihood Enhancement through Action Research and Networking) programme of the Department of Science and Technology. The project envisage to introduce decentralized, cost-effective and easy to adapt habitat solutions. Jal TARA Water Filter system was installed at the community building in Kamad village. The system is easy to maintain and community members have been trained in its maintenance.

This manual has been prepared as a guide for the use of entrepreneurs and government departments for installation of decentralized community operated water treatment systems in mountain regions. The manual comprises of six sections. The Background provides context and the rationale for proposing this technology in mountain regions. Second Section presents the technical details of the system. The next two Sections cover the installation, operation and maintenance requirements of the treatment system. Ownership and Management Sections highlight the process of community involvement in functioning of the system. The last Section presents the costing of the Filtration System.

Background

India has a population of 1.3 billion people and one of the biggest contemporary challenge for this growing population is access to safe drinking water. The contamination of sources of water – rivers, ground water, spring etc. is one of major factors for lack of availability of safe drinking water. The contamination of water sources takes places in three forms – Physical, biological and chemical.

- **Physical contamination** is characterized with respect to the sense of sight, touch, taste or smell. It includes characteristics such as PH, Turbidity, Colour, Taste, Odour and Temperature.
- **Chemical contamination** is concerned with the capacity of water to dissolve various salts. These are mostly related to the ions dissolved in water i.e. cations- Ca, Mg, Fe, Na, K, etc. anions-NO₃, PO₄, CO₃, etc.
- **Biological contamination** is due to bacteria, fungi, viruses, protozoa and other micro-organisms.

In India, most of the water-related health problems are due to bacterial contamination. Water borne diseases are mainly prevalent in semi-urban and rural areas due to lack of proper sanitation facilities and also the lack of access to health care facilities. Water borne diseases of major public health concern include typhoid caused by *Salmonella typhi*, Cholera by *Vibrio cholerae* etc. Besides biological contamination, physical contamination i.e. Turbidity is another area of concern especially in rural community water supply systems. High erosion in streams, less stream flow depth, loose sandy aquifers, etc are the main reasons for turbid waters. In India, there is urgent need for cost effective, maintenance free community level water treatment systems. Chlorination, Reverse osmosis, U.V. treatment, Ozonation and Resin treatment are the commonly practiced techniques in eliminating biological contamination and turbidity. However none of the systems is reliable and cost effective for community water supply. Of all these techniques, sand filtration offers a chemical free, reliable and economical treatment.

Sand filters commonly used for water treatment are of two types a slow sand (2 to 6m³/m²/day) and rapid sand (100 to 150 m³/m²/day) filters. Though there are many other ways of treating water, no single process is as effective in simultaneously improving microbiological and physico - chemical qualities of water as slow sand filtration. It is for this reason that slow sand filters are very much favoured in developing countries where land and labour constraints are not pressing, and the ease of operation, maintenance and cost are most important.

This manual describes installation, maintenance and management processes of Jal-TARA slow sand filter system in rural areas of mountain region. Although, the technology is adaptable in different geographies – plains, coastal and hilly regions. This manual can be used by anyone who wish to learn about slow sand filter technology and install it in their communities but this manual specifically describes the processes adapted in installation of Jal-TARA slow sand water filter in Kamad village, Uttarkashi district, Utrakhnad, India.

Context – Uttarkashi

In many parts of mountaineous regions, natural springs and rivers are primary sources of water used in domestic activities – drinking, cooking, bathing, cleaning utensils and latrine washing (in cases where toilets are being used). As per survey conducted by Ministry of rural development in 2009, 13 sources out of 23 sources in Uttarkashi district were found to be contaminated with faecal matter (source: IMIS 2009). In the DST TIME LEARN project, testing of water samples from 7 different sources of water in 3 villages (Kamad, Bharkot and Siror) in Uttarkashi showed that 6 sources were contaminated with faecal matter (*E. coli*). The Central Ground Water Board in 2009 also analysed that ground water and spring water, have high concentration of nitrate, sodium and magnesium than the permissible limit in Uttarkashi district (source: CGWB,2009).

Due to their remote location, it is difficult to install water supply infrastructure in these mountain villages and even more difficult to install and maintain an electricity-dependent water treatment system. Therefore, there is a need to address the water quality issue through a solution that can be managed and serviced by the village community for sustained use. In this context, the Jal-TARA water filter was identified as an appropriate technology for the mountain villages. The technology is capable of removing bacterial contamination completely, utilizes local materials for its treatment process and requires no electrical energy for its operation and maintenance (except for pumping water into the treatment system).



Installed Jal TARA water filter at community building in Kamad village, Uttarkashi

Jal-TARA Water Filtration Technology



Concept

Jal – TARA water filter technology was the R&D product of Development Alternatives and marketed by TARAlife Sustainability Solutions Pvt. Ltd., a social enterprise promoted by Development Alternatives (DA) Group.

The Jal-TARA water treatment system is based on the principle of slow sand filtration. Slow sand filtration is a type of centralised or semi-centralised water purification system. A well-designed and properly maintained slow sand filter (SSF) effectively removes turbidity and pathogenic organisms through various biological, physical and chemical processes in a single treatment step. Only under the prevalence of a significantly high degree of turbidity or algae-contamination, pre-treatment measures (e.g. sedimentation) become necessary. Slow sand filtration systems are characterised by a high reliability and rather low lifecycle costs. Moreover, neither construction nor operation and maintenance require more than basic skills. Hence, slow sand filtration is a promising filtration method for small to medium-sized, rural communities with a fairly good quality of the initial surface water source. As stated by the WHO, slow sand filtration provides a simple but highly effective and considerably cheap tool that can contribute to a sustainable water management system.

Slow sand filtration ensures a mainly bacteriological, some chemical and physical improvement in water quality comparable to the natural percolation of water through underground strata. This natural process is further enhanced in the Jal-TARA filter by introducing a fabric disc at the start of the filtration sequence.

Advantages

- Complete removal of E. coli (bacterial contamination) and turbidity in water
- Chemical Free, Potable Water at affordable cost
- Requires no electricity for operation and maintenance
- Can be easily maintained by the user community with basic training.
- Requires no replacement of its filtration materials for 10 years

Filtration mechanism

The Jal-TARA filter is a biological filter employing the advanced technique of fabric protection to improve and simplify the traditional processes of slow sand filtration. Two kinds of filtration processes occur simultaneously to improve the quality of the water. Physical filtration occurs in which the fabric filter prevents most organic matter, silt and mud particles from passing through. In Biological filtration, a biological community builds up on fabric filter and sand bed, scavenging and breaking down unwanted pathogens and organic matter in the raw- water.

It removes three types of impurities –

- Large and fine particles of suspended matter which are deposited on the surface of the filter bed by the action of mechanical straining and sedimentation respectively.
- Colloidal and dissolved impurities are removed by adsorption process while passing through layers of sand and pebble bed in the filter medium.
- Organic matter gets converted into harmless gasses and inorganic salts by the purification mechanism of the fabric disc. Most microbiological action takes place in the 'Schmutzdecke' (Bio- film) formed in the fabric filter at the top of the filter and top of the sand bed.

The filtration process occurs in the following stages -

(1) Raw-water enters the top half of the tank where heavier suspended matters are removed by settlement/sedimentation.

After passing through the fabric filter disc (2), the water passes down to the uppermost fine sand bed (3), where further removal of particulate matter occurs and biological filtration begins.

At the uppermost horizon of the coarse sand bed (4) any remaining particulate matter is removed. Here, and further down the filter, is a region of intense biological activity which breaks down trapped impurities and pathogens. Gradually the degradable organic contaminants are converted to harmless products like water, carbon dioxide and inorganic salts.

In the lower horizons of the sand bed (5) biological activity diminishes until at the interface with the gravel support where very little activity remains. In these lower horizons, the chemical and physical processes of adsorption and oxidation remove the remaining products of biological activity.

(6 &7) From the gravel support the pure water is collected by the pipe system.

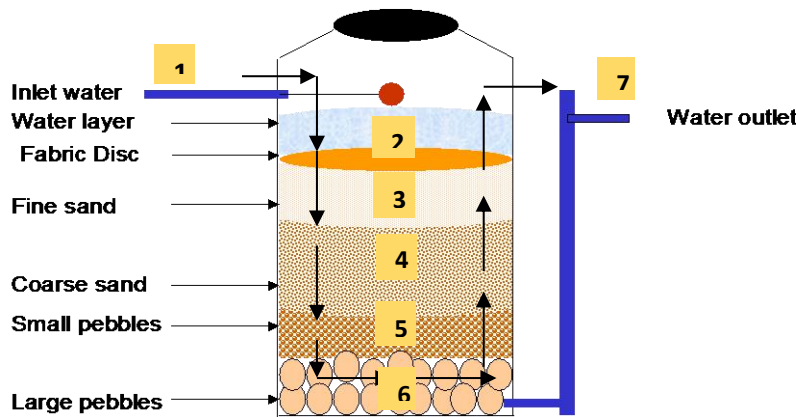

Diagram of filtration mechanism of Jal TARA slow sand filter.



Jal TARA water filter tank.

Design of filtration system

Jal-TARA slow sand water filter system comprises of three water tanks – Raw water tank (Tank A), Jal-TARA Filter Tank (Tank B) and Filtered water storage cum distribution tank (Tank C). These three tanks are placed and inter-connected with each other in such a way that water is transmitted from Tank A to B to C by gravity. Depending on the location of the water source and specific geographical features of the location, the raw water tank can either be fed by gravity flow from the source or will need a pump.

Tank A is used as a raw water storage tank and connected with a source of raw water (water pipeline, or any other natural source of water), usually with a capacity of 1000-2000 litres. Tank B is a Jal-TARA filter tank with a capacity of 1000 litres (detailed specification provided in section 2.3). Tank C is a treated water storage tank with a capacity of 1000 litres to store filtered water and with a connection/s to a water outlet tap. If the water filter and the connected plumbing fixtures are properly maintained, then the Jal-TARA filtration system will be able to provide an output of 3000 litres of potable water every day at a flow rate that can be adjusted to between 1.5-3.0 liters per minute, depending on the need of the end users.

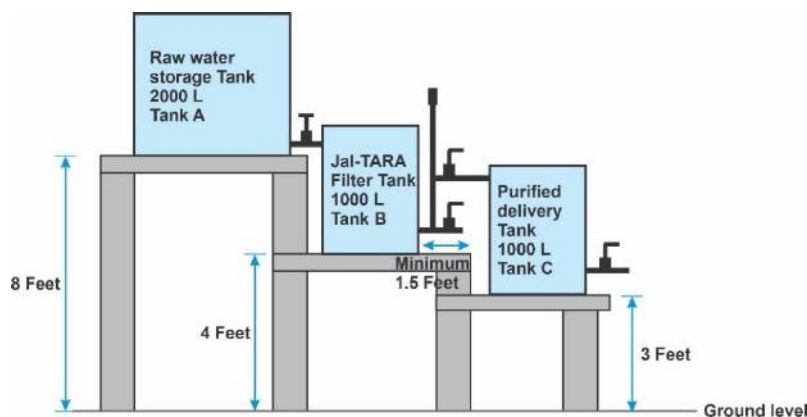

Diagram of Jal-TARA water filtration system and their placement on the required platforms.

Components of the treatment system

Platform for water tanks

Three tanks are placed at different heights – these are raw water storage tank (Tank A), treatment tank (Tank B) and treated water storage tank (Tank C) in decreasing heights. Tank C is placed at minimum height of 3 feet and maximum 5 feet from the ground, depending on the height at which water is to be drawn from the tap. The height of the bottom of the tank B should be at least one foot higher than the bottom of the tank C. and the height of the bottom of the tank A should be 4 feet higher than the Tank B. The size for each platform for placing the tanks should be minimum 5feet x 5feet. There should be sufficient space between Tank B and Tank C - minimum 1.5 feet to install inter connecting pipes. (See *Diagram of Jal-TARA water filtration system and their placement on the required platforms.*)

The platforms for tanks can be constructed using locally available materials- these could be materials used in masonry such as burnt clay bricks, stone or concrete blocks. The platform should be constructed in good quality masonry and should be capable of bearing the weight of tanks. The weight of the raw water and treated water tanks is approx. 1000Kg each and the weight of Jal-TARA filter tank is approx. 1500 Kg. It is preferable to use a combination of masonry and a horizontal RCC slab for placing the tanks. In case masonry is not feasible, then a Mild Steel (MS) frame can be constructed. While an experienced mason is skilled enough to construct the masonry supports, the Steel frame should be constructed as per design approved by an engineer.

It is preferable to install the treatment system close to an existing building such as in this case, the topmost tank for storing raw water can be placed on the building terrace and only two platforms need to be constructed. If reasonably good quality masonry materials are available, then the vertical part of the platform can be constructed in one-and-a-half brick (13"-14") thick masonry or 12" thick concrete block masonry or 15" thick stone masonry in cement mortar. If all three platforms need to be constructed as a stand-alone system, then the masonry till the height of the middle tank should be 2 brick thick (18") and masonry from middle to topmost tank can be one-and-a-half brick. In earthquake prone regions, such as mountain regions, 8 feet high masonry (for the raw water tank) should form corners by turning in L-shape and should be reinforced with single 8mm bar reinforcement at the corners. The masonry or steel frame should rest on a proper foundation at least 2 feet deep or till adequately strong soil strata.

Jal-TARA water filter

Jal-TARA slow sand filter is standardized in 1000 litres water tank with the output water supply of 2000-3000 litres per day. The nature's way of how slow sand filtration process takes place is replicated in the Jal-TARA filter through its multiple layers of pebbles/stones and sand of different sizes, in combination with a single layer of synthetic fabric filter. The gradation of the filter media size is the most important factor for filtration efficiency.

The filter media comprises of the following layers in bottom-top sequence -

1. Large pebbles of size above 20 mm
2. Small pebbles of size 10mm-20 mm.
3. Layer of coarse sand
4. Layer of fine sand and
5. Covering of with a fabric disc.

Each layer has to be with depth of 20-25 cm and overall filter medium depth is 90 cm. The filter tank is required to be covered all the time. (Refer section 2.3)

Plumbing

Inlet water pipe at the top of the Tank A, along with ball valve and ballcock or float valve. Ball valve is required to control the pressure and flow of water from the source in the tanks and ballcock is required to avoid overflow and backflow of water in the tanks. Inlet pipe in each tank is provided with ball valve and ballcock. Bottom of Tank A is connected with the top of the Tank B is with the same system.

Tank B to Tank C is connected with a small horizontal pipe along with ball valve, this is provided to out flow any excess water in the filter tank during cleaning of the tank. The same horizontal pipe is also connected with a vertical pipe called long pipe or air pipe with a cap. The long pipe is required to avoid high flow rate, as it break the flow of water and doesn't allow water to flow directly in Tank C. Air cap is provided to avoid any air blockage and removal of any excessive gas in the water system.

An inlet horizontal pipe is connected at the middle of the long pipe to Tank C for filter water storage and lastly an outlet pipe is provided with a tap at the bottom of the Tank C to withdraw filtered water for use. Several other plumbing parts are required, while installing these connections in the water system. The plumbing parts required are as follows-

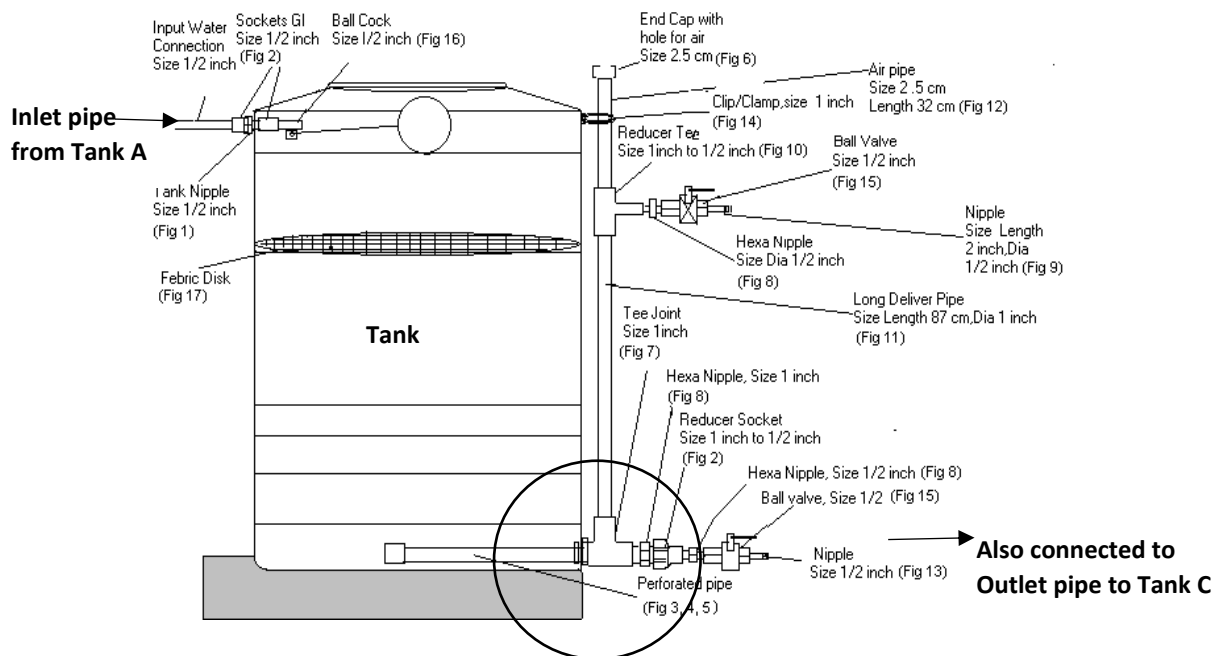

Jal – TARA water filter tank (Tank B) plumbing details

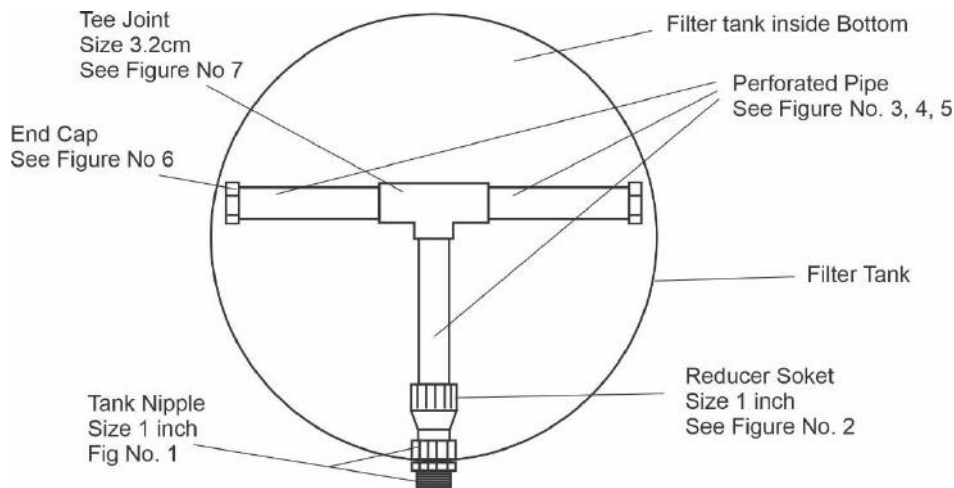

Perforated pipe connection details

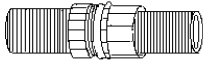

1: Tank Nipple GI

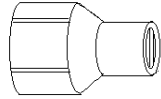

2: Reducer Socket pvc/GI
Size 1 to 1/2 inch

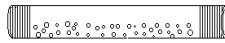

3: Perforated Pipe
Size: Length=48cm, Dia 3.5cm

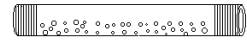

4: Perforated Pipe
Size: Length=48cm, Dia 3.2cm

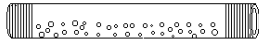

5: Perforated Pipe
Size: Length=48cm, Dia 3.2cm



6: End Caps
pvc size 1 inch



7: GI (Metallic)
Size 1 inch, Tee Joint

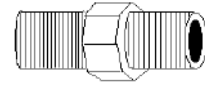

8: Hexa nipple
Size 1 inch



9: Nipple
Size 15 mm

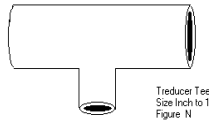

10: Reducer Tee Joint
Size 1 to 1/2 inch

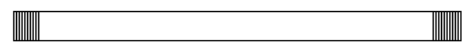

11: Long Delivery Pipe
Size: Length, 87cm, Dia 2.5cm

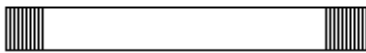

12: Air Pipe
Size: Length, 32cm, Dia 2.5cm



13: Air Pipe
Size: Length, 32cm, Dia 2.5cm

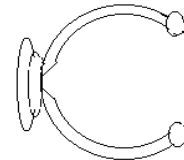

14: Clip/Clamp
Size 1 inch

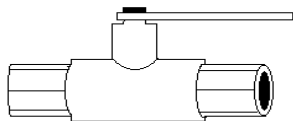

15: Ball Valve
Size 1/2 inch

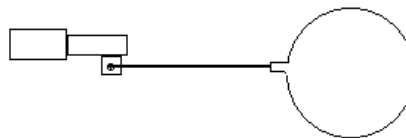

16: Ball Cock
Size 12mm

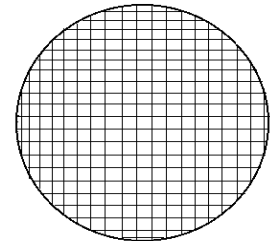

17: Fabric Disk

List of Plumbing Materials for Jal-TARA filter Installation

S No.	Item Name	Size	Specification	Quantity	Remarks
1.	Tank nipple	1/2 inch	GI (ISI Mark)	One	Figure No 1
	Tank nipple	1 inch	GI (ISI Mark)	One	Figure No 1
2.	Reducer socket	1 inch	Pvc (ISI Mark)	One	Figure No 2
3.	Perforated pipes	L = 18.8inch Dia = 1.3 inch	Pvc (ISI Mark)	Three	Figure No3,4,5
4.	End capes	1 inch	pvc(ISI Mark)	Two	Figure No 6
5.	Tee joint	1inch	GI metallic (ISI Mark)	One	Figure No 7
6.	Hexa nipple	1 inch	Pvc GI (ISI Mark)	One	Figure No 8
7.	Nipple	½ inch	Pvc /GI (ISI Mark)	Two	Figure No 9
8.	Reducer Tee Joint	1 inch to ½ inch	Pvc /GI (ISI Mark)	One	Figure No 10
9.	Long Delivery pipe	Length 34.2 inch, Dia 0.9 inch	Pvc	One	Figure No 11
10.	Air pipe	Length 12.5 inch, Dia 0.9 inch	Pvc	One	Figure No 12
11.	Nipple	½ inch	Pvc /GI (ISI Mark)	Two	Figure No 13
12.	Clip/ Clamp	1 inch	pvc	Two	Figure No 14
13.	Ball valve	½ inch		Three	Figure No 15
14.	Ball cock	½ inch	pvc	one	Figure No.16
15.	Fabric Disc	42 inch dia	Pp, pvc, nylon	One	Figure No.17

Importance of The Ball cock and Ball valve

The Ball cock and Ball valve are designed to carry out the following functions:

- To act as a control valve to regulate the rate of flow of water through the system.
- To avoid the need for regular adjustment of valves.
- To ensure that a minimum level of water in the system remains above the level of the sand bed to avoid drying out of the biofilm (see Fig F. With Fig. no 15, 16 for Ball cock & Ball valve).
- To ensure a constant Head (h) of water.

Installation and Operation

The water filtration system is easy to install at any site in rural, urban, semi-urban and remote areas. Jal TARA filter tank can be assembled with locally available material like sand and pebbles. However, if not available locally, the material required can be easily transported. The installation system is broadly categorized in two phases-Pre-installation Phase and Installation Phase. This section elaborated the installation processes followed to install same system at Kamad village, Uttarkashi, as an example.

Site selection

- Ensure that all the units must be sited on well firm level ground. A concrete slab is ideal but not essential. In the absence of a slab a firm working surface should be laid around the units using available material for example stones, gravel, bricks or wood.
- Make provisions for runoff and soak way of overflow (0.5m³/min) and wash waters (1m³/min) and also for handling sand that has been removed and replaced during skimming operations (30-40kg/unit).
- Prepare sketch or drawings showing dimensions of the site for planned layout. Ensure that sufficient space is allowed for operator access and for the convenient location of inlets, interconnections and runaways.

The system installed in one of the community buildings in the Kamad village, Uttarkashi is surrounded with schools and village temple, and hence the location is easily accessed by the villagers. The technology is best suited for small, compact settlements, as it has a capacity to filter 2000-3000 litres of water every day and serve upto 100-150 people every day @ 20 liters per capita. The surrounding schools comprise of almost 300 students and teachers. Hence this technology was chosen to be suited best for the area.



The selected site at one of the community building in Kamad village, Uttarkashi to install the water system.

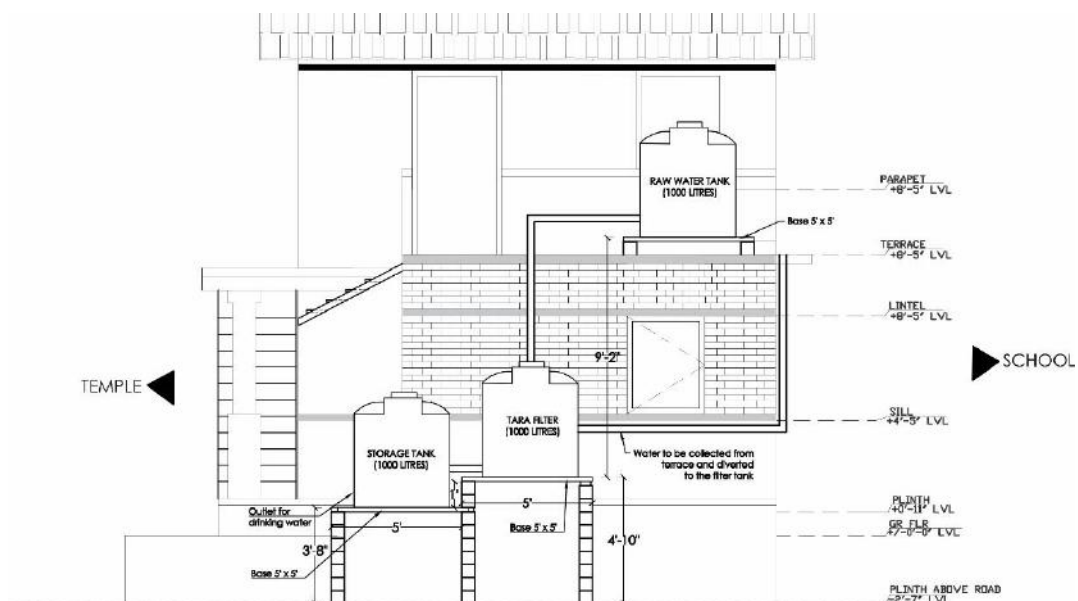

Design developed at pre installation stage after site selection.

Identification of the filter media

Choice of sand for filter

- A good sand bed is of paramount importance for the successful operation of the filter. The World Health Organization (WHO) has laid down standards for ideal sand for slow sand filtration applications (see the Graph below of WHO).
- In many situations it will not be possible to procure the exact material. However the Jal-TARA filter is designed to allow in-situ washing and grading of the sand bed, permitting the use of a wide range of locally available sands.
- As a general rule the coarser grades of washed sand are most suitable. Sand that is too fine will lead to rapid blockage of the sand bed. Sand with a very high clay or silt content should be avoided or very thoroughly washed. Beach or river sand if available is normally a very good.

Testing of sand for filter –

If it is possible to carry out a particle size analysis of the sand available, by sieving through different sizes of sieves. Then a graph can be generated which shows the optimum range of size distribution. Two other parameters are useful:-

Effective size - The effective size of the sand is defined as the sieve size through which 10% of the sand passes, this should be between 0.15 to 0.35mm.

By drawing a graph of % passing Vs sieve size this parameter can be easily read off.

Coefficient of Uniformity- This is defined as the sieve size through which 60% of the sand passes divided by the sieve size through which 10% of the sand passes.

A useful means of roughly assessing sand quality is to shake a sample of sand with water in a full glass jar and allow it to settle. The clay and silt fraction will be revealed as layer on the surface of sand. Lesser this layer more suitable the sand.

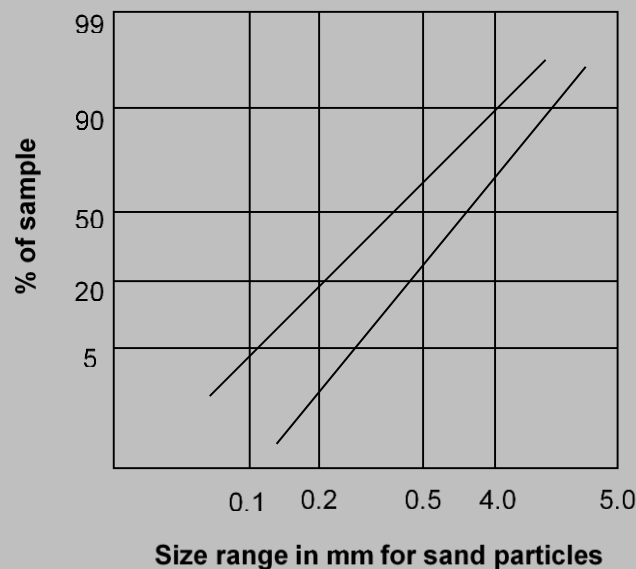

WHO (graphno.1) Limits for size distribution of particles for slow sand filters

List of Components for Jal-TARA filter Installation

S No.	Item Name	Size	Specification	Quantity	Remarks
1.	Plastic Filter Tank (Black) With Lid	1000 litre	Base Dia 110 cm Height 120 cm Mouth Dia 40 cm	One	Good quality, UV radiation proof
2.	Fabric Filter Disc	-		One (fig. 17)	
3.	Cement Platform below tanks	Dia 110 cm Height 10 cm or more	Uniform and flat	One /Two	Highly strong to take water filled tank load
4.	Continuous Water supply point near to Jal- TARA filter (tank)	½ inch (15mm)	preferable if turbidity of input water is less than 25 NTU, otherwise pre filtration tank needed	One	-
5.	Filtered water storage Tank	1000 litre or as per actual requirement	-	One	Good quality
2.	Sieves	0.5mm, 1.0mm, 5.0mm	Metal	One each	
3.	Washed Stone	15mm to 20mm	-	4.5 cubic feet (app)	
4.	Washed Stone (Zeera)	5mm	-	2cubic feet	
5.	Washed Sand (Coarse)	1mm and above	-	2 cubic feet (App)	
6.	Washed Sand	0.5 mm to 1.0 mm	-	3.5 cubic feet	
7.	Washed Sand	Less than 0.5mm	-	17.5 cubic feet	

In addition, Aqua Check Vials are needed to check for bacterial contamination in water. Around 20 Aqua Check Vials are needed for establishing the pre-treatment and post-treatment water quality during installation of the filter and for periodic checks post installation

Construction of platform for water filter tanks

The installation process of Jal-TARA slow sand water filter requires 2 -3 days out of which 1 day is for assembling the filter medium and other 1-2 days for the backwashing of the filter for removal of any existing impurities in the filter medium. The entire water system takes 2 weeks for installation – site preparation, construction of stand, transportation and installation of water tanks, installation of filter tank and setting up plumbing fittings.

Material and Labour procurement -

- Arrange all the required materials for installation of Jal-TARA filter, like plumbing materials, tanks and different particle sizes of sand and stones as per Section 2.
- The labour requirement for the installation of the system has been mentioned in section-6 of this manual.

Stage - 1 Site levelling and construction of stand

- Site identified for the installation of water system must be levelled properly with a firm base.
- In the water system installed in Kamad village, the platforms are constructed in 8” thick concrete block masonry on 12” concrete block foundation. The base for the water tanks is constructed with precast RCC planks which have been used for intermediate slab in the adjoining community building. The size of platforms is as shown in schematic diagram on page 10



Preparation and installation of Jal-TARA filter

Stage - 2 Filtration tank preparation and installation

- Prepare an elevated strong flat cemented circular platform of about 10cm height and 110cm diameter on a roof.
- Ensure that the plastic tank of 1000 litres for filter unit is devoid of any cracks or holes.
- Install the filter tank near the input water supply with the help of a plumber and a few labours.
- Place the tank on the specially prepared flat cemented platform.
- Make a round hole, 2.5cm above the bottom of the tank, to fix a 25mm diameter pipe.
- Now fix the three perforated pipes, tank nipple, reducer socket, Tee joint and End cap at the bottom of tank (see section 2.5)
- Keep the level of the filtered water storage tank lower than the Jal-TARA filter tank at least by 1 foot (see figure 4 in section 2.4)
- Fix the long delivery pipe as well as the other components like hexa nipple, ball valve, reducer Tee joint, nipples, long delivery pipe, air pipes, clip/clamp, ball cock and fabric filter disc (See section 2.5)
- Check for water pressure and water continuity at input point of the filter.

Stage - 3 Laying the Stones and Gravel

- Spread stones (preferably of grain size 15mm to 20mm over the bottom of the tank until the drainage cross is completely covered(upto appr. 4.5 cuft).
- Uniformly spread a further layer of gravel (grain size 5mm) over the top of the stones at least half way up the first step of the tank upto appr.2 cuft.
- Gravel is used to support the sand and prevent the passage of sand into the drainage cross.

Stage - 4 Laying the sand bed

- It is desirable that the grade of sand selected should be as close as possible to that recommended by the WHO for slow sand filtration (as shown in graph above).
- In extreme cases the sand can be prewashed in a drum or tank to remove heavy loadings of clay.
- Fill the tank evenly with sand to a level above the Gravel (stone level) as indicated in (Fig. D) approximately 3.5 cuft



Sieving process of sand

Stage - 5 Inserting Fabric Filter Disc inside the Tank

- The synthetic material inside the Fabric disc has been specially designed and has the following functions.
- Take the Fabric filter disc and fold it as shown below. Insert through the muoth of the filter tank. Gently open up the folds inside the tank & lay down the disc on the sand layer.
- Ensure that the sand particles don't come out at the top of the fabric disc.
- Now put three stones or brick blocks at three different positions on the circumference of fabric disc in order to prevent floating of the fabric disc.

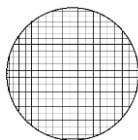

1: Fabric Filter Disc Unfolded

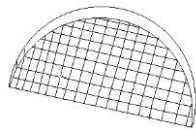

2: Fabric Filter Disc with 1st fold

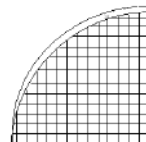

3: Fabric Filter Disc w. 2nd fold

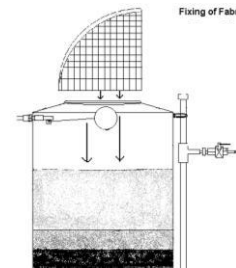

4: Fixing of Fabric Filter in the Tank

Stage -6 Placement of Lids

- The filter tank lid prevents the growth of Algae and excludes mosquitoes which might otherwise breed in the tank. It also avoids contamination of the raw water with undesirable materials from external sources.



Stage -7 Installation of raw water and filtered water storage tank

- The raw water tank has to be placed 4 feet above the filter tank and filtered water tank has been placed 1 feet below the filter tank.
- In Kamad village, raw water tank has been placed over the roof of the building, provided with 4 inch concrete base and filtered water tank 1 feet below on concrete base platform. Both the tank are connected to Jal-TARA filter tank with appropriate plumbing.



Importance of filter disc

- Excludes silt and organic matter from the sand bed.
- Provides an extended habitat for the beneficial microbiological populations responsible for the improvement in hygienic quality.
- Maintains the biological population even during cleaning operations thus ensuring rapid

Stage -8 Plumbing connections

- Raw water storage tank to be connected with appropriate nearby water pipeline.
- Make all the required plumbing connections between the three tanks for raw water, treatment and storage of treated water. For details of plumbing connections, refer section on Plumbing on page 12,13
- In some cases electrical water pumping system will be required to provide sufficient water pressure into raw water tank.



Stage -9 Operationalizing the filter

Back washing of the filter tank and cleaning of storage tanks

- Once the system is installed, backwashing processes of Jal-TARA filter has to be done.
- The objective of this process is to pass water upwards through the bed fluidising the sand and carrying away any clay, silt, mud and organic debris. At the same time the sand grades itself, coarser particles settling to the bottom and finer particles being carried to the top. Skim off the top 5cm sand layer, then remove any undesirable fine material having a clean well graded bed.
- Backwashing process required to be done for minimum 6-8 hours and might take longer depending on the impurities in the filter medium.



Quality of water in filter tank at three stages- left: after 2 hrs of backwashing, middle: after 6-7hrs of backwashing, right: after 12 hrs of backwashing.

The Ball cock device calibration

Calibration of filter throughput and filtration velocity

The rate of flow of water from the system determines the filtration velocity (down flow velocity) and is adjusted by setting the Ball cock position up and down manually.

- ☞ Estimate the flow of water through the system using a stop watch and a measuring cylinder or a container of accurately known volume say 5 litres. The adjustment of the Ball cock position must be done until the desired flow rate is achieved.

The maximum output of the system is 2.0 lit/m. If the maximum flow rate is not required by the community then the Ball cock position can be calibrated down to as low as required (But not less than 1.0 lit/min).

Stage -10 Measuring the flow rate

- Connect the filter tank to the input water supply system. Water generally takes a few hours to come out of the outlet.
- Now allow water to flow from the outlet for a few minutes & don't utilize it.
- Measure the flow rate of the outlet in a measuring cylinder. Flow rate has to be fixed between 1.3 litres/minute. To adjust the flow rate, position of the ball cock can be changed. This way appropriate head loss can be adjusted to get the desired flow rate.

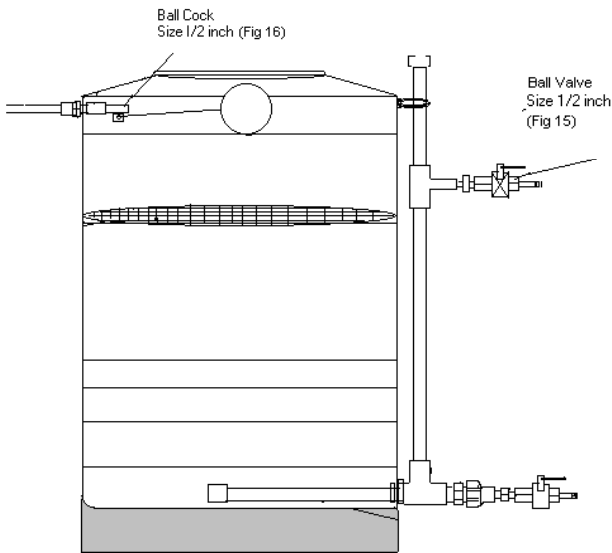

Details of ball valve and ballcock connections to the filter tank



Ball valve



Ballcock

Stage -11 Water testing of filtered water

- The water system is made completely open for public use after one flush from the filtered water tank.
- Water testing is conducted of the second storage of filtered water in the storage tank. It can be done in two ways – one is to take the sample of water to appropriate nearby lab, for this minimum 1 litre of water sample is required. And second, is to test it by using Aqua Check Vials supplied by testing vials. TARA water testing vials were used in this case.

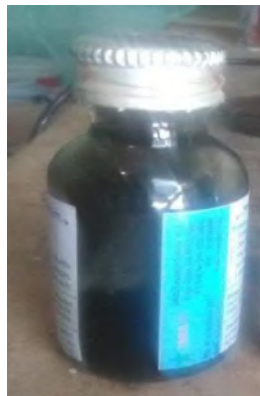

Vial testing – tested raw water turned black indicating bacterial contamination in raw water sample.



Image of vial with light brown colour indicates that water is fit for drinking.

Determination of Flow Rate (*in lit/min*) = Volume of water collected (litres) / Time taken to collect (minute)

Filtration velocity = Flow rate (l/min) x60m/hr / Filter area (m²) x 1000

Note: Allow sufficient detention time in the filter to ensure efficient functioning of the physical, chemical & biological processes described above. The detention time is determined by the rate of flow of water through the system. In the Jal-TARA Filter the fabric filter disc enhances the process to allow efficient operation at considerably higher filter rates than in conventional slow sand filtration systems. In the Jal-TARA filter, the rate of passage of water through the filter bed must be maintained to 2.0 litres/minute.

Maintenance



The Jal TARA water filtration system has low maintenance requirements. Cleaning of the Filter is the main work to be undertaken to keep the system running smoothly. Frequency of cleaning will depend on- 1) sand particle size and porosity, 2) level of impurities in the input water supply (in terms of turbidity & bacterial contamination) and 3) rate of filtration.

Routine Maintenance

This comprises of two operations, the frequency of which will depend on the quantity, particularly the turbidity, of the raw water.

- Skimming of the top 5cm sand layer (once in a year).
- Washing of the Fabric filter disc (twice in a year).

Establish a maintenance schedule to ensure that regular attention is given to these tasks. Arrange one person from the community to be given specific responsibility for this. Regular attention to the task will help in extending the intervals between washing and skimming operations of the filter.

Skimming of the sand bed

When the sand bed gets clogged and clogging can't be tackled by washing alone, then skimming off the top sand layer is recommended. This operation can be expected to be required once in a year with following procedure:

- *Drain the filter to just below the sand level, remove the filter disc and wash it.*
- *Have a large bucket or drum to wash the sand removed during the skimming process.*
- *Scrape off the top 5cm of sand from the filter bed. Take care to do this smoothly and cleanly and to avoid mixing any of the dirty sand with the clean lower layer. A small tool of wood, plastic or metal can easily be improvised to assist in the operation.*
- *Transfer the sand to the washing container and fill with equal volume of water. Vigorously agitate the sand to dislodge the coating of slime. Pour off the soiled water and repeat the process until the water remains clear.*
- *To replace the cleansed sand in the filter, dig a shallow pit in the bed, placing the dug sand to one side. Fill the bottom of the pit with the cleansed sand and cover the original sand, spreading it, as necessary, to leave an even surface. This procedure is recommended as upper layers of the sand bed, even after skimming, are still biologically active whilst the washed sand is effectively devoid of biomass. Thus the efficiency of the filter is best maintained by replacing the washed sand in the lower, less active, horizons of the bed.*

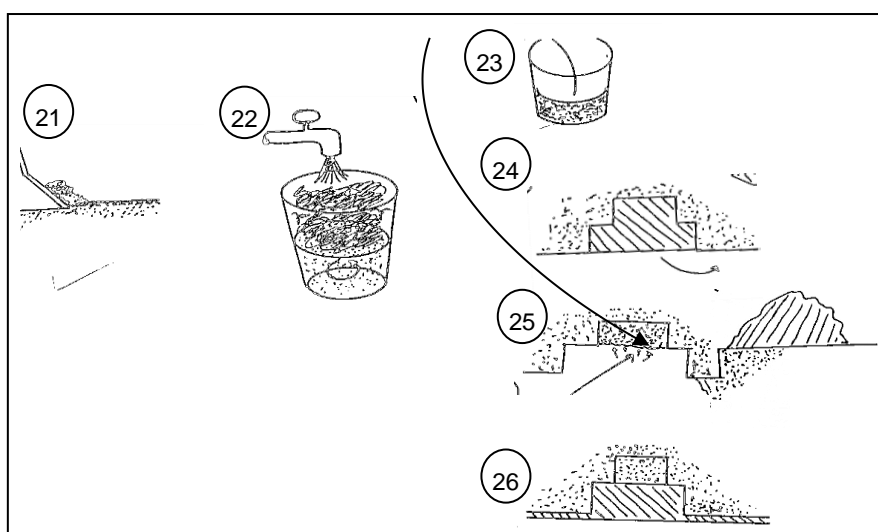

Sketches explaining the process of skimming.

This procedure reduces but does not completely eliminate the active biomass. Thus for a period of 24 hrs the water from the cleaned filter should be diverted away from the community supply. If terminal chlorination is practiced, the above procedure need not be observed.

Washing of the Fabric filter disc (twice in a year)

- First close the input water valve to stop the water supply to the system.
- Now take out the fabric filter disc (FFD) gently and carefully.
- Wash the fabric filter disc (FFD) with a jet of water. For proper removal of the dirt which gets deposited on the surface of the fabric filter disc (FFD), a soft nylon hair brush may be quite helpful. Use it for rubbing and cleaning mainly at the top side of the fabric filter disc (FFD) as all the dirt can flow down with flowing water force.
- Now insert the fabric filter disc (FFD) into the tank by folding gently and unfold after inserting. Set it properly with the help of stone/ brick blocks so that it remains immersed in water.
- Now start the input water supply to the system by opening the water supply valve and it should be ensured that optimum outflow remains the same.
- Run the system for at least one week without using its output water. After one week of running, the system would achieve its full efficiency.
- Use the water for drinking purpose after one week Ensure treated water storage tank is kept clean all the time.

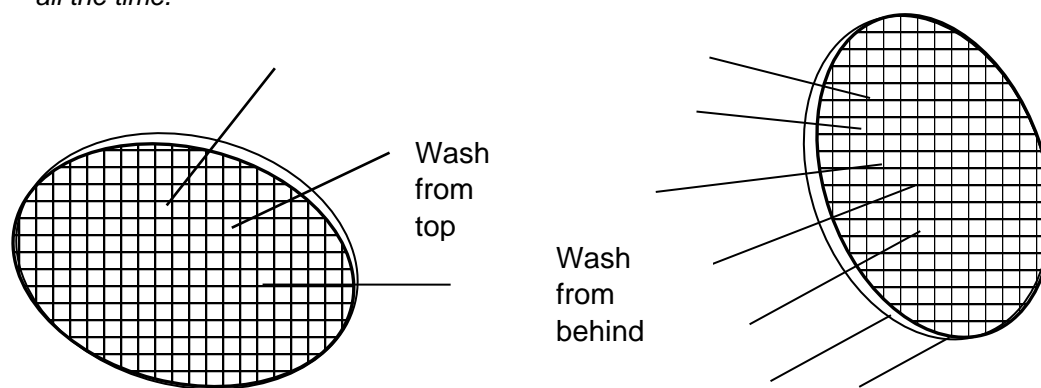

Washing method of fabric disk from top and behind.

Special Maintenance

Back Washing

Back Washing is needed when flow rate of the filtered water slows down.

If the filter bed gets clogged with excess silt and accumulated biomass and if the routine maintenance procedures do not successfully restore the permeability (required flow rate) then filter is required to undergo special maintenance, like **Back Washing** of the filter.

The Back Washing process involves passing of water upwards through the bed fluidising the sand and carrying away any clay, silt, mud and organic debris. At the same time the sand grades itself, coarser particles settling to the bottom and finer particles being carried to the top. Skim off the top 5cm sand layer, then remove any undesirable fine material. To get a clean well graded bed, the following procedure need to be followed-

- Remove the Fabric filter disc from the tank by folding gently and smoothly.
- Open the valve of drainpipe fitting, connect the raw water supply to the tank and pass water vigorously (with speed) up through the bed until the supernatant water (water on the top layer) is clean. The process is aided by stirring the bed with a stick or shovel, taking care not to disturb the gravel support. It is particularly important to ensure that no unwashed pockets of sand remain in the bed when the process is complete.

- *Allow the filter to drain down to below the level of the sand and skim off the top 5cm of sand from the bed. Take care to remove the sand smoothly and cleanly, avoiding any mixing with the layer below.*
- *Place the Fabric filter disc to its position.*
- *Close the valve of drainage outlet.*
- *Open the inlet valve, allow the filter to refill and in this way the filter will be back in service.*
- *A ripening period of at least 5 days (to allow for the restoration of biological film) should be allowed after this process before the product water is reconnected to the public supply.*

Ownership and Management



As explained in the previous sections, the Jal-TARA slow sand filters are decentralized community managed water systems, requiring minimal maintenance that includes only seasonal cleaning of filter fabric disc and periodic Back Washing. It can function for 10-15 years without any major maintenance requirements. In order to make it completely community operated it was essential to train local stakeholders in the technicalities, functionality and future maintenance procedures of the water filter system. A day long training can be designed in form of Focus Group Discussions (FGD), group and individual technical trainings for stakeholders in order to make it completely community operated. The design and number of the community trainings would vary as per the context and the participation level of the community. Below are the details of the training module followed in Kamad village, Uttarkashi.

A day long training session was designed and conducted including two parts – 1 & 2. Part-1 was conducted in form of Focus Group Discussion (FGD) with the beneficiaries of water filter – school children, teachers and village residents in this case. The objective of the FGD was to aware beneficiaries regarding the importance of safe drinking water and its practices. They were mobilized to take responsibility of management and maintenance of Jal-TARA water filter.

Part-2 of the training was conducted as a technical training of a local person who can further take charge of long term maintenance of the water filter. The objective of technical training was to build capacity of a local person in technical/plumbing details of the filter, who can maintain the installed filter model and take on entrepreneurship in further installation of similar models in the region.

Training- Part 1

The participants in the first part of the training (FGD), were 40 school children and 9 teachers from two nearby schools – Modern school and Swami Vivekanand Shiksha Sansthan, Kamad, Uttarkashi. Village *Sarpanch* as a Gram Panchayat representative and local residents also participated in the discussion.

FGD was conducted with a part awareness session on water related health problems and the types of water contamination found in the region from testing reports. Trainer specifically discussed with school teachers regarding the responsibility of conducting awareness activities with students on the need for sanitation, hygiene and safe drinking water practices. Each participant was informed about the functionality and benefits of slow sand water filter installed in the region. They were also informed about its capacity to provide water around 3000 litres everyday which can fulfill daily water needs of about 250 school children, teachers and even their families. Simple water testing methods used to test the portability of filtered water through vials were shown to the participants, in order to build their trust in the filter. Lastly, general information regarding the long term functionality of water filter was provided by giving successful examples slow sand filters in other regions. This built the credibility of the water filter among the community.

Outcomes: The FGD was attended by 40 school children, including class monitors from each classroom, each student took a pledge to take care of the filter. Head master and school teachers of both the schools participated in the FGD among which headmaster of Swami Vivekanand Shiksha Sansthan School took the responsibility of the water filter and to bear monthly charges of water bill and other minor maintenance charges of the water filter. *Sarpanch* of the village agreed with the decisions and approved to sign a letter of support on behalf of Gram Panchayat.



Photo showing FGD conducted with school children, teachers, village sarpanch and local residents by trainer.



Trainer showing participants how to use Aqua Check Vials for testing the filtered water. (before and after filtration to check the efficacy of the filtration system)

Training- Part 2

This part of training is more technical, Mr. Gajendar Singh Rana (local resident) who also supported in the installation of the filter was trained in detailed technicalities, functionality and long term maintenance requirements of the water filter.

He was explained about the formation of filter medium comprised of different layers of aggregate, sand and fabric disk. He was also explained about the functionality of various parts of the water system - air pipe, ball cock, valves, fabric for bio film formation and the seasonal cleaning requirements – fabric disk and tank cleaning, back washing for long term maintenance. Methods to ensure long term potability and safety of filtered water through monthly checking of filtered water quality using Aqua Check vials. Further, he was also trained on how to check and control flow rate, how to do trouble shooting etc.

Outcomes: 2-3 key stakeholders were trained as an expert in installation and maintenance of slow sand water filter. They understood the functionality of each part of water system and well equipped to identify the problem and fix it in water system. They were also trained as a future entrepreneur who can install such filters in the region in future.

Cost of the System



Costing of Water system at Kamad village, Uttarkashi

S No.	Item	Quantity	Rate (INR)	Amount (INR)
	Jal – TARA water filter tank			
1	Tank (1000 litre capacity)	1	14,000	14,000
2	Fabric disk	1	5,000	5,000
3	Plumbing fittings – Tank nipple, GI socket, reducer socket, perforated pipe, end cap, tee joint, hexa nipple, nipple, reducer Tee, long deliver pipe, Air pipe, clamp, ball cock, fabric disk	As per specifications mentioned in Table no. 1	19,000	19,000
	Total (A)			38,000
	Other Plumbing fittings			
1	Raw water tank (1000 litre capacity)	1	4,500	4,500
2	Filtered water tank (1000 litre capacity)	1	4,500	4,500
3	MS pipe (1/2 inch)	3	835/ pipe	2,500
4	MS angle	20	60/ piece	1,200
5	PVC Pipe (1 inch)	3	550/ pipe	1,650
	Total (B)			14,350
	Material for filter medium			
1	Fine sand	4.5 cuft	1,200/ cuft	5,400
2	Coarse sand	3.5 cuft	1,200/ cuft	4,200
3	Fine aggregate (10-20mm)	2 cuft	2,500/ cuft	5,000
4	Large aggregate (Above 20mm)	4.5 cuft	2,500/ cuft	11,250
	Total (C)			25,850
	Material for stand			
1	Concrete blocks	200	60/ Block	12,000
2	Precast RCC planks	10	800/ Plank	8,000
3	Cement	2 Bags	500/ Bag	1,000
4	Sand	5 cft	1,200/ cuft	6,000
5	Aggregate	5 cft	2,500/cuft	6,000
	Total (D)			33,000
	Labour charge			
1	Mason(3 days)	1	700/day	2100
2	Helper (3 days)	2	500/day	3,000
3	Plumber (2 days)	1	700/day	1,400
	Total (E)			6,500
	Total (A+B+C+D+E)			1,17,700

*These are tentative basic costs calculated in March 2019 prevailing, components & service valuations. For Aqua Check Vials and other water testing field testing kits, TARAlife Sustainability Solutions Pvt. Ltd., can be contacted. (www.taralife.in)



About Development Alternatives Group

Development Alternatives (DA) is a premier social enterprise with a global presence in the fields of green economic development, social equity and environmental management. It is credited with numerous technology and delivery system innovations that help create sustainable livelihoods in the developing world. DA focuses on empowering communities through strengthening people's institutions and facilitating their access to basic needs; enabling economic opportunities through skill development for green jobs and enterprise creation; and promoting low carbon pathways for development through natural resource management models and clean technology solutions.

Development Alternatives
B-32, Tara Crescent, Qutub Institutional Area
New Delhi 110016, India
Tel: +91-11-2654-4100, 2654-4200, Fax: +91-11-2685-1158
Email: mail@devalt.org, Website: www.devalt.org